

DHI-NVR608RH-128-AI/ANZ

128 Channels 2U 8HDDs WizMind Network Video Recorder



Launched by Dahua Technology, Dahua WizMind is a full portfolio of solutions composed of project-oriented products including IPC, IVSS, NVR, PTZ, XVR, Thermal and software platform which adopts industry-leading deep learning algorithms. Focusing on customer's requirements, WizMind provides precise, reliable and comprehensive AI solutions for verticals.

Series Overview

As a new generation of network video recorders, NVR600-AI/ANZ series offers high-grade recording technology and has AI capabilities that are ideal for IP video surveillance applications. This enterprise-level NVR has a powerful processor, built-in deep learning modules, and video metadata technology. It also comes with high-precision human face recognition, perimeter protection and 4K resolution, which together shorten the response time to events and provide critical information that allows surveillance personnel to take immediate action. This NVR is compatible with numerous third-party devices, making it a perfect solution for surveillance systems with or without a video management system.

Functions

Perimeter Protection

Automatically filters out false alarms caused by animals, rustling leaves, bright lights, etc. Enables system to act secondary recognition for the targets. Improves alarm accuracy.

Face Recognition

Dahua Face Recognition technology extracts the features of captured faces and compares them with that in face database to recognize the person identity.

- 32-channel 1080p self-adaptive decoding capability.
- Max. 1024/1024/800Mbps incoming/recording/outgoing bandwidth.
- Supports N+M cluster.
- Support Raid0/1/5/6/10.
- Drawer-like chassis design allows for HDD hot swapping.
- AI by recorder: 4-channel face detection and recognition; 8-channel metadata; 24-channel perimeter protection; 32-channel SMD Plus.
- AI by camera: Face detection and recognition, perimeter protection, SMD Plus, metadata, ANPR, and people counting.

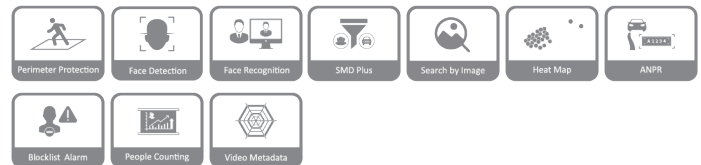

SMD Plus

With intelligent algorithm, Dahua Smart Motion Detection technology can categorize the targets that trigger motion detection and filter the motion detection alarm triggered by non-concerned targets to realize effective and accurate alarm.

Video Metadata

With deep learning algorithm, Dahua Video Metadata technology can detect, track, capture vehicle, non-motor vehicle and people, and select the best images, and extract attributes.

Heat Map by Camera

Dahua heat map technology is used to display the crowd density and people appearance probability. Export and display the crowd status by different colors. Generally, the crowd status is the statistics of people quantity in space and time dimensions.

ANPR by Camera

With deep learning algorithm, Dahua ANPR technology can recognize the number plate information of vehicles in the image with ANPR cameras. Support blocklist/allowlist mode, searching target vehicles from recorded video.

Technical Specification

System

Main Processor	Industrial-grade processor
Operating System	Embedded Linux
Operating Interface	Web, Local GUI

AI

AI by Recorder	Face detection; face recognition; video metadata (human, motor vehicles, and non-motor vehicles); SMD Plus
AI by Camera	Face detection; face recognition; video metadata (human, motor vehicles, and non-motor vehicles); SMD Plus; stereo analysis; crowd distribution; people counting; ANPR; vehicle density; object monitoring

Perimeter Protection

Perimeter Performance AI by Recorder (Number of Channels)	24 channels, 10 IVS rules for each channel
Perimeter Performance of AI by Camera (Number of Channels)	64 channels

Face Detection

Face Attributes	Gender; age group; glasses; expressions; face mask; beard
Face Detection Performance of AI by Recorder (Number of Channels)	4 channels (up to 12 face images/s each channel)
Face Detection Performance of AI by Camera (Number of Channels)	64 channels

Face Recognition

Face Database Capacity	Up to 40 face databases with 300,000 images, with a total capacity of 48 G. Name, gender, birthday, address, credential type, credential No., countries & regions and state can be added to each face image.
Face Recognition Performance of AI by Recorder (Number of Channels)	1. 20 channels FD (by camera) + FR (by recorder), image stream: 20 face images/s 2. 4 channels FD (by recorder) + FR (by recorder), video stream: 12 face images/s
Face Recognition Performance of AI by Camera (Number of Channels)	64 channels

SMD Plus

SMD Plus by Recorder	32-channel: Secondary filtering for human and motor vehicle, reducing false alarms caused by leaves, rain and lighting condition change
SMD Plus by Camera	64 channels

Video Metadata

Metadata Performance of AI by Recorder (Number of Channels)	8 channels
Metadata Performance of AI by Camera (Number of Channels)	32 channels
Human Attributes	Top color, top type, hat, bag, age, gender and umbrella

Motor Vehicle Attributes	License plate, plate color, vehicle model, vehicle logo, plate color, ornament, calling,
Non-motor Vehicle Attributes	Vehicle model, vehicle color, number of persons, helmet.

Vehicle License Plate Comparison

ANPR by Camera (Number of Channels)	32 channels
License Plate Database Capacity	Blocklist and allowlist: 20,000

Audio and Video

Access Channel	128 channels
Network Bandwidth	AI disabled: 1024 Mbps incoming, 1024 Mbps recording and 800 Mbps outgoing AI enabled: 512 Mbps incoming, 512 Mbps recording and 400 Mbps outgoing
Resolution	32 MP; 24 MP; 16 MP; 12 MP; 8 MP; 5 MP; 4 MP; 1080p; 720p; D1
Decoding Capability	2-channel 32 MP@30 fps; 2-channel 24 MP@30 fps; 4-channel 16 MP@30 fps; 8-channel 8 MP@30 fps; 16-channel 4 MP@30 fps; 32-channel 1080p@30 fps; 72-channel 720P@30 fps 160-channel D1@30 fps
Video Output	2-channel VGA, 4-channel HDMI video output. Simultaneous mode: max. resolution of VGA1 and VGA2 is 1080p, max. resolution of HDMI1 and HDMI2 is 4K max. resolution of HDMI3 is 8K max. resolution of HDMI4 is 1080p Heterogeneous mode: Simultaneous video source output for VGA1 and HDMI1 Simultaneous video source output for VGA2 and HDMI2 max. resolution of VGA1 and VGA2 is 1080p, max. resolution of HDMI1, HDMI2 and HDMI3 is 4K max. resolution of HDMI4 is 1080p
Multi-screen Display	Main screen: 1/4/8/9/16/25/36/64 Sub screen: 1/4/8/9/16/25/36
Third-party Camera Access	ONVIF; RTSP; Sony; Axis; Arecont; Pelco; Canon; Samsung

Compression Standard

Video Compression	Smart H.265+; H.265; Smart H.264+; H.264; MPEG4; MJPEG
Audio Compression	G.711a; G.711u; PCM; G726

Network

Network Protocol	HTTP; HTTPS; TCP/IP; IPv4; RTSP; UDP; NTP; DHCP; DNS; SMTP; UPnP; DDNS; Alarm Server; IP Search (Supports Dahua IP camera, DVR, NVS, etc.); Multicast; P2P; Auto Registration; ISCSI
Mobile Phone Access	iOS; Android
Interoperability	ONVIF (Profile S/profile T/Profile G); CGI; SDK
Browser	Chrome IE 9 or later Firefox
Network Mode	Multi-address mode, load balance, fault tolerance and other network port binding modes

Recording Playback

Multi-channel Playback	Up to 16 channels
Record Mode	Manual; alarm; motion detection; scheduled
Backup Method	Portable hard drive, eSATA disk, burner, USB device and network
Playback Mode	1. Play, pause, stop, fast forward, fast backward, rewind, play by frame 2. Full screen, backup (cut/file), partially enlarge, audio on/off

Storage

Disk Group	Yes
RAID	RAID 0/1/5/6/10
Hot Swapping	Yes

Alarm

General Alarm	Motion detection; video tampering; video loss; scene changing, PIR alarm, IPC external alarm
Anomaly Alarm	Camera offline; storage error; disk full; IP conflict; MAC conflict; login lock; abnormal behavior of fan
Intelligent Alarm	Face detection; face recognition; perimeter protection (intrusion and tripwire); SMD Plus alarms; ANPR; people counting; stereo analysis; crowd distribution; heat map
Alarm Linkage	Record; snapshot; IPC external alarm output; buzzer; log, preset; email

Port

Audio Input	1-channel RCA
Audio Output	2-channel RCA
Alarm Input	16 channels
Alarm Output	8 channels
HDD Interface	8 SATA ports, up to 16 TB. The maximum HDD capacity varies with environment temperature.
eSATA	1
RS-232	1
RS-485	1 × A/B
USB	4 (2 front USB 2.0 ports, 2 rear USB 3.0 ports)
HDMI	4
VGA	2
Network Port	2 (10/100/1000/2500 Mbps Ethernet port, RJ-45)

General

Power Supply	100–240 VAC, 50/60 Hz
Redundant Power	Yes
Power Consumption	<18 W (without HDD)
Net Weight	8.14 kg (17.95 lb) (without HDD)
Gross Weight	12.24 kg (26.98 lb) (without HDD)
Product Dimensions	444.0 mm × 476.0 mm x 95.0 mm (17.48" × 18.74" × 3.74") (W × D × H)
Packaging Dimensions	571.0 mm × 618.0 mm × 219.0 mm (22.48" × 24.33" × 8.62") (W × D × H)
Operating Temperature	-10 °C to +55 °C (14 °F to +131 °F)
Operating Humidity	10%–93% (RH)
Installation	Rack or desktop
Certifications	FCC: 47 CFR FCC Part15, SubpartB, Class A CE-EMC: EN 55032:2020, Class A; EN IEC 61000-3-2:2019; EN 61000-3-3:2013+A1:2019; EN 55024:2010+A1:2015; EN 55035:2020; EN 50130-4:2011+A1:2014 CE-LVD: EN 62368-1:2014+A11:2017

Ordering Information

Type	Model	Description
128 Channels WizMind NVR	DHI-NVR608RH-128-AI/ANZ	128 Channels 2U 8HDDs WizMind Network Video Recorder
Accessories	ESS1504C	4 HDDs eSATA Storage

Accessories



ESS1504C
4 HDDs eSATA Storage

Dimensions (mm[inch])

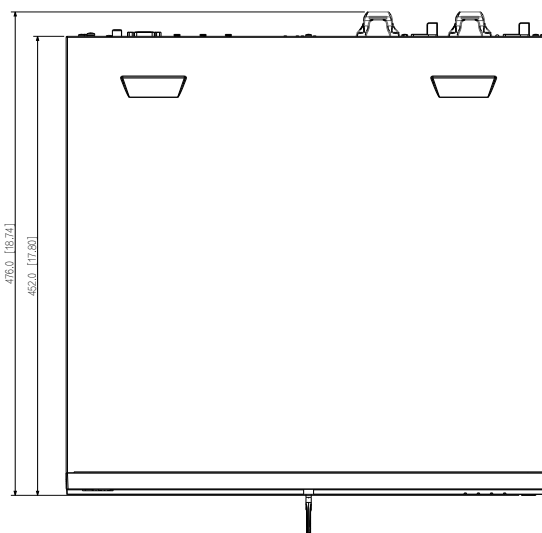
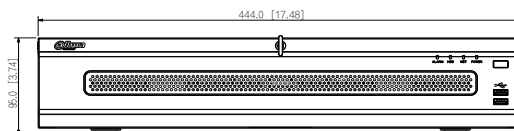

Panels

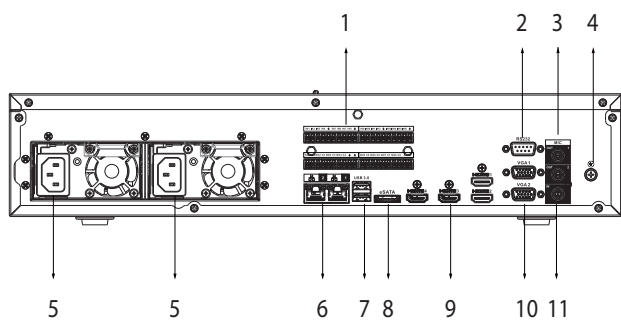

- | | | | |
|----|--------------------------|----|---------------|
| 1 | Alarm In/Out | 2 | RS-232 Port |
| 3 | AUDIO OUT, RCA Connector | 4 | Ground |
| 5 | Power Input | 6 | Network Ports |
| 7 | USB Ports | 8 | eSATA Port |
| 9 | HDMI Ports | 10 | VGA Ports |
| 11 | AUDIO IN, RCA Connector | | |